

COMSAT Laboratories Review

Systems, Technology
and Products

1999



Delivering the Future. Now. SM



*Providing technical excellence
in systems, services, and products
for global communications.*

CONTENTS

Welcome	1
Achievements	2
Overview	3
Technology & Products	4
Systems	15
Test & Evaluation Services	21
Contact Information	24

Welcome to COMSAT Laboratories

1999

COMSAT Laboratories, a business unit of COMSAT Corporation, provides advanced communications products and consulting services to customers throughout the world. For more than 30 years the Laboratories has pioneered the development of satellite technology, and we are committed to meeting our customers' needs by providing technical excellence in systems, services, and products for global communications. One measure of this commitment is the Laboratories' attainment of ISO 9001 certification—meeting a stringent international management standard that ensures quality in product and service development. Our major customers include AT&T, Ericsson, EUTELSAT, ICO, Inmarsat, INTELSAT, Lockheed Martin, NASA, SS/Loral, Telespazio, and the US Army.

Consulting efforts at COMSAT Laboratories encompass all aspects of satellite systems and technology, including the analysis, design, and specification of satellite ground and space systems, and the development of communications and network systems, in-orbit test facilities, and specialized onboard satellite components. We also offer support in the areas of satellite construction monitoring, antenna verification testing, subjective evaluation tests, and battery life cycle testing.

Over the years, and through the innovation of its employees, COMSAT Laboratories has been issued more than 300 US Patents in advanced satellite technologies, from flat plate antennas through ATM and Internet via satellite. Today, the Laboratories' advanced communications products include LINKWAY™ 2000—a bandwidth-on-demand, multiservice mesh networking product; Internet, Frame Relay, and ATM transmission equipment; INTELSAT 120-Mb/s TDMA; flat plate antenna products; MPEG2 video compression equipment; and satellite planning and management software.

This review describes the services and products offered by COMSAT Laboratories. We welcome further inquiry; contact information is provided on the inside back pages of this publication.

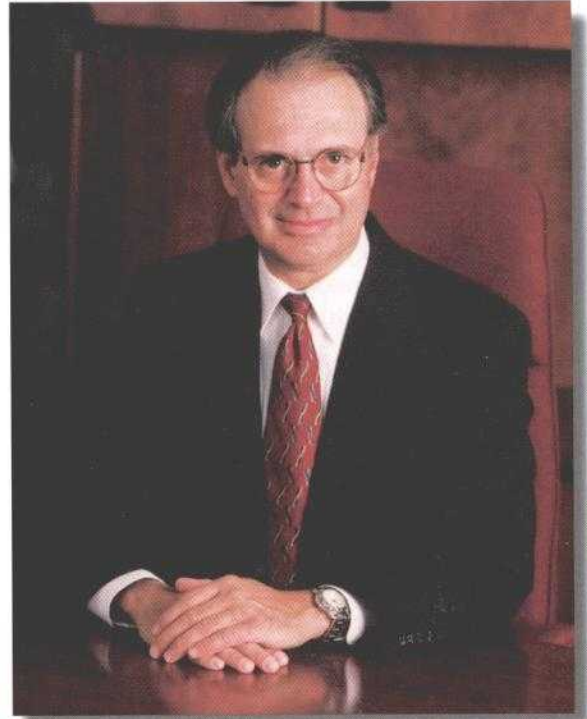

B. A. Pontano

Dr. Benjamin A. Pontano
President, COMSAT Laboratories



COMSAT Laboratories Achievements

Space Technology Hall of Fame

COMSAT Laboratories was one of the recipients of the 1997 NASA/US Space Foundation Space Technology Hall of Fame Award. The award was presented at the US Space Foundation's Space Symposium on April 3, 1997, in recognition of COMSAT Laboratories' significant contributions to the success of the Advanced Communications Technology Satellite (ACTS) Program. The NASA ACTS Program played a major role in the renaissance of the communications satellite industry.

COMSAT Laboratories was a member of the NASA Glenn Research Center ACTS Team, which conceived and developed the ACTS system. The ACTS Program was recognized for its contributions to both space technology and spin-off developments. COMSAT Laboratories designed, built, installed, and today operates the ACTS Master Ground Station equipment at NASA Glenn. This station is the primary control and operations center for the ACTS program.

The Space Technology Hall of Fame program recognizes technologies originally designed for space program requirements, and later adapted for commercial application. Established in conjunction with NASA in 1988, the US Space Foundation administers the program to honor innovators who have transferred technology, to increase public awareness of space spin-off technology, and to encourage further technology development.

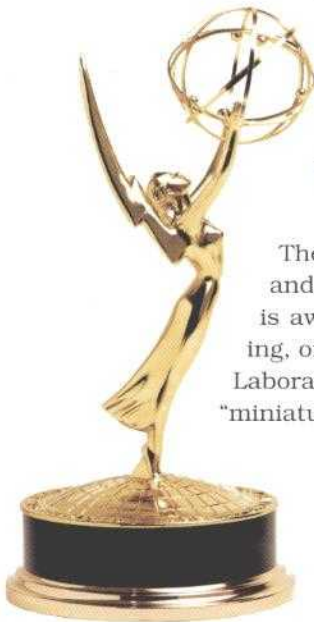
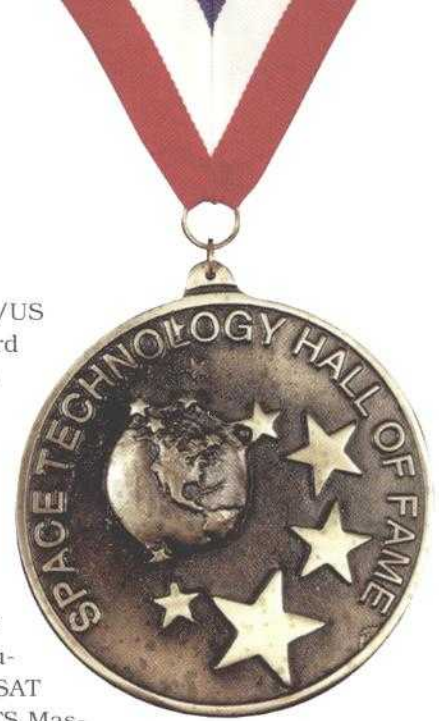

The Emmy

The Emmy—the highest honor bestowed by the National Academy of Television Arts and Sciences (NATAS) on an individual, company, or scientific/technical organization—is awarded for major advances that “materially have affected the transmission, recording, or reception of television.” In presenting the statuette to COMSAT, NATAS praised the Laboratories for its “outstanding achievement in the sciences of television technology” for “miniature, lightweight, rapid deployment earth terminals for satellite newsgathering.”

Newsgathering via satellite has become an indispensable element in the virtually instantaneous reporting demanded by the global community today. This technology has played a crucial role in bringing the people of the world face to face with the human side of major events and rapidly unfolding political crises worldwide.

Intellectual Property

COMSAT Laboratories has an extensive patent portfolio covering many aspects of satellite communications technology. This portfolio includes approximately 100 active patents, with another 70 in the filing process. The technologies covered by these patents include Asynchronous Transfer Mode (ATM), Frame Relay, and Internet Protocol (IP) via satellite; modem, coding, and encryption; voice and video encoding; flat plate and phased-array antennas; microwave filters and components; space-qualified batteries; multiple-access techniques and synchronization; and onboard digital signal processing.

COMSAT Laboratories Overview



Established in 1967, COMSAT Laboratories has provided more than three decades of world leadership in satellite communications. The Laboratories' original charter was to perform leading-edge research and development for the INTELSAT satellite system. The success of the INTELSAT global satellite system is a testament to the early pioneers at COMSAT Laboratories.

Today, COMSAT Laboratories provides advanced satellite and wireless communications products and technical consulting services to commercial and government customers around the globe. COMSAT Laboratories is located in Clarksburg, Maryland, on a 230-acre campus along the Interstate 270 High Technology Corridor, about 35 miles north of Washington, DC.

This Review describes COMSAT Laboratories' capabilities and achievements in the following areas:



A Commitment to Quality

COMSAT Laboratories received ISO 9001 certification in March 1999. The Laboratories is committed to increasing customer satisfaction through:

- on-time delivery
- fully compliant services
- defect-free products
- meeting customer needs and expectations.





COMSAT Laboratories offers advanced satellite system design, technology, and product development. The Laboratories is currently focusing on broadband multimedia and mobile network systems and products that make efficient use of bandwidth, provide fiber-like quality, and improve performance for applications operating over satellite and wireless links.

TECHNOLOGY & PRODUCT DEVELOPMENT

COMSAT Laboratories' development efforts encompass RF and satellite communications and network technologies. Included are advanced satellite system design; reflector, flat plate, and phased-array antenna design and development; propagation modeling and analysis; lithium-ion battery research and development; voice encoding; forward error correction; signal processing, ASIC, onboard processing, and modem development; bandwidth-on-demand; frequency-division, code-division, and time-division multiple access system development; seamless interoperability of the integrated services digital network (ISDN), asynchronous transfer mode (ATM), Internet, and Frame Relay terrestrial and satellite networks (including national and international standards participation); Global System for Mobile Communications (GSM) integration with satellite systems; and communications systems operational solutions.

Advanced Satellite System Design

The Laboratories' capabilities for the design of advanced satellite systems include transmission system design and analysis, interference analysis, system architecture development, system design evaluation, traffic and protocol modeling, network simulation, terrestrial user interfaces, and specification development.

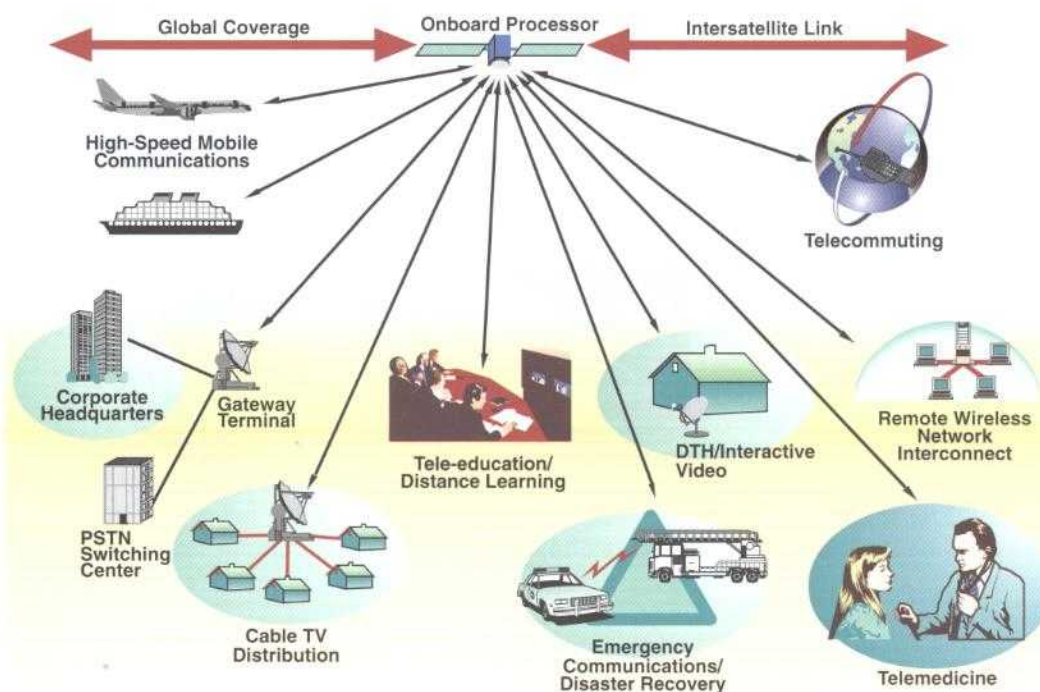

COMSAT Laboratories is a world leader in building satellite-based communications system architectures for multimedia applications.

Satellite Systems Architectures

COMSAT Laboratories has been actively involved in research, development, and systems engineering for emerging satellite communications systems, including satellite personal communications services (PCS), multimedia Ka-band and V-band systems, satellite audio broadcast systems, and a stratospheric telecommunications system. Systems engineering support has been provided for commercial satellite PCS systems such as ICO, ACeS, Agrani, Ellipso, and second-generation systems. The Laboratories' involvement in Ka-band systems has included ACTS, Canadian Advanced Satcom, Astrolink, CyberStar, and Teledesic. Also, technical support has been provided to WorldSpace and CD Radio for satellite audio broadcasting.

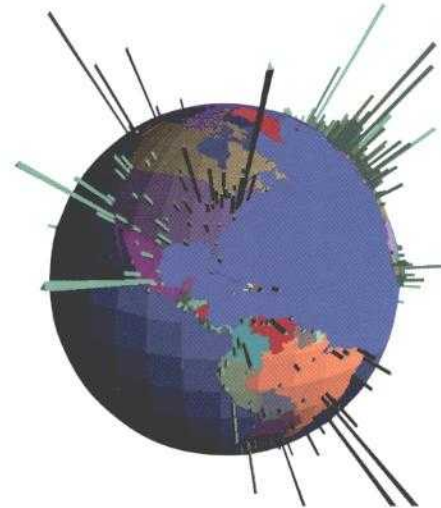

In this 3D model of global interference, the spikes indicate the locations and strengths of interferers.

Traffic Analysis and Protocol Performance

Traffic analysis, network optimization, and protocol performance evaluation are integral components of telecommunications network design. COMSAT Laboratories' capabilities in these areas combine analytical techniques, computer simulations, and test bed evaluations.

In the area of traffic analysis, the Laboratories has developed multimedia traffic models for advanced Ka-band and next-generation mobile satellite systems. These models have been integrated with ATM, Frame Relay, and TCP/IP protocols—as well as higher layer applications—to optimize and evaluate the performance of multimedia satellite/terrestrial systems, mobile voice and data systems, and bandwidth-on-demand systems. COMSAT Laboratories' extensive test bed setup has been used to assess protocol performance, identify interoperability issues, and optimize equipment configurations.

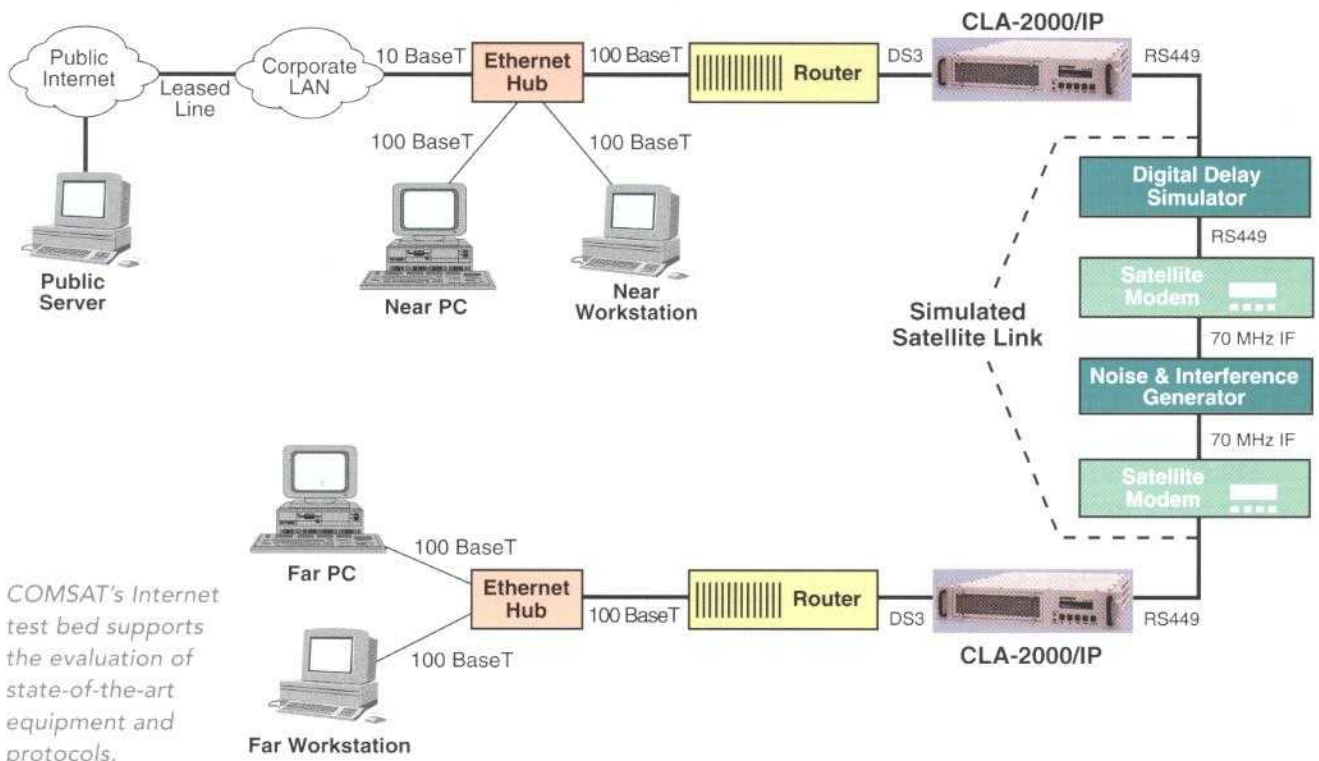

COMSAT's Internet test bed supports the evaluation of state-of-the-art equipment and protocols.

LINKWAY™ 2000

COMSAT Laboratories' LINKWAY™ 2000 product is a multicarrier, multirate, time-division multiple access (TDMA) satellite network terminal that is fully compatible with existing communications satellites. It offers ATM, IP, Frame Relay, ISDN, and SS7 interfaces for state-of-the-art, full mesh network connectivity.

The LINKWAY 2000 product enables single-hop satellite network connectivity with multiservice switched bandwidth-on-demand for voice, video, data, and multimedia applications. Unlike conventional VSAT systems, the LINKWAY 2000 terminal allocates satellite bandwidth dynamically for both packet- and circuit-switched services. This significantly reduces space segment costs for broadband services. In addition, single-hop connectivity eliminates the need for an expensive central hub station. The LINKWAY 2000 terminal employs COMSAT Laboratories' patented technologies to ensure reliable transmission and maximum availability of data, even when operating under degraded satellite link conditions.

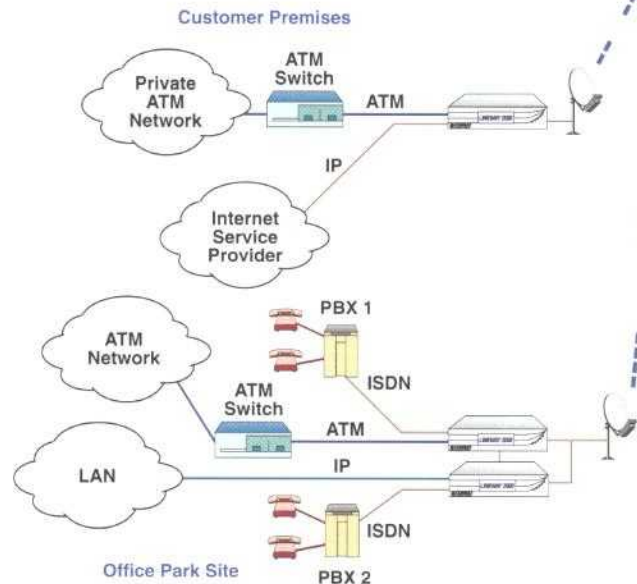

The easy-to-use, Java™-based Web browser graphical user interface to the LINKWAY 2000 Network Management System (NMS) is platform-independent and permits both remote and local access to network control and status information. It offers a quick and easy method for performing centralized management, monitoring, control, configuration, and accounting functions. Multiple levels of access control are available to ensure system security.

KEY FEATURES OF THE LINKWAY™ 2000 PRODUCT

- Full-mesh, single-hop connectivity.
- Demand-based automatic adaptive bandwidth assignment.
- ATM, Frame Relay, IP, ISDN, and SS7 services.
- Dynamic bandwidth allocation for variable bit rate (VBR) and unspecified bit rate (UBR) ATM, Frame Relay, IP, ISDN, and SS7 traffic.
- Capability to allocate satellite bandwidth across multiple transponders in a single satellite, permitting easy network expansion.
- IP routing, with support for RIP-1, RIP-2, OSPF, and BGP-4 options, as well as static multicast.
- Access to the Network Management System (NMS) through the World Wide Web for PC-based remote clients.
- Support for C- and Ku-band operation with standard RF terminals (RFTs) and antennas.
- Support for various terminal sizes in a single network, allowing a mix of customer premises, office park, and gateway locations.
- Highly integrated board design for reliability and efficiency.
- Fully integrated modem within the LINKWAY 2000 indoor unit (IDU).
- Multiple-beam and inclined orbit operation.
- Completely configured turnkey systems available.
- Worldwide installation and support services provided by global partners.
- ISO, CE, UL, TBR28, and FCC certifications.

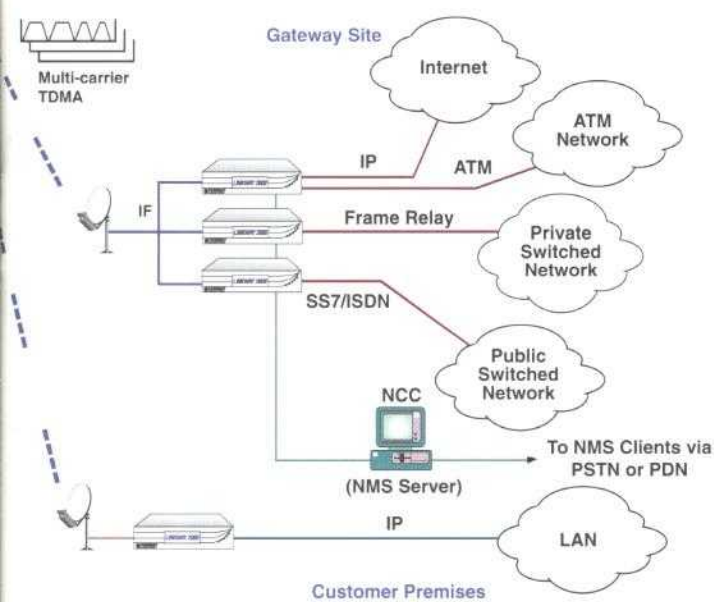

COMSAT Laboratories' link accelerators.

COMSAT Laboratories' Link Enhancer

COMSAT Laboratories' Link Enhancer (ALE-2000) is a link conditioning device for interconnecting ATM networks at DS3 and E3 rates. It uses a novel technique of interleaving and dynamically inserting Reed-Solomon forward error correction (FEC) into the data stream, with no overhead bandwidth penalty.

COMSAT Laboratories' Link Accelerators

For Internet: CLA-2000/IP is a routing device optimized to carry Internet traffic over satellite and wireless links. It operates at fractional T1 to 4-Mb/s symmetric or asymmetric data rates and offers innovative features such as congestion control and TCP spoofing for high data throughput.

For ATM: CLA-2000/ATM is a link conditioning device that allows the interconnection of ATM networks over wide area networks (WANs). It operates at fractional T1 to 8.448 Mb/s data rates, with ATM cell header compression and lossless ATM cell payload compression.

For Frame Relay: CLA-2000/FR enables the interconnection of frame relay networks via satellite and wireless links. It operates at symmetric or asymmetric rates and features bit rate adaptation and lossless data compression.

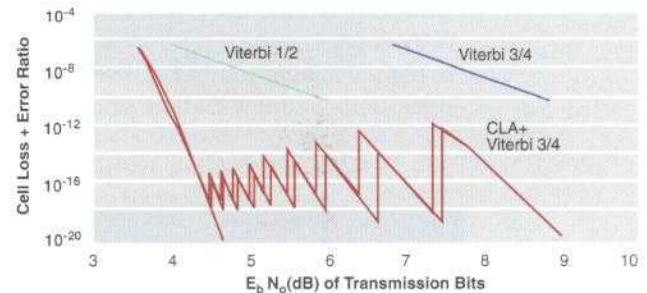

The COMSAT Laboratories ALE-2000 improves cell loss ratio (red curve) by several orders of magnitude.

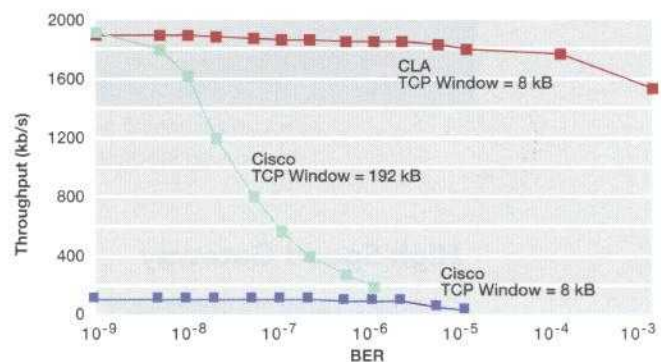

Single TCP Connection, Large Data Transfer (20 - 40 min)
Link Rate = 2.048 Mb/s, One-way Delay = 250 ms
Sun Solaris 2.6

The Laboratories' CLA-2000/IP provides high Internet throughput, even under degraded link conditions.

High Penetration Notification

COMSAT Laboratories conceived, designed, and developed the high penetration notification (HPN) subsystem to be used in the ICO ground network. ICO's medium earth orbit system will be used for handheld communications worldwide. The HPN subsystem is designed to reach ICO customers located inside buildings, who would normally be out of the range of satellite signals. It is an integral component of the ICO satellite access nodes (SANs), which will be located at 12 sites around the world.

The HPN subsystem hardware architecture is based on a high-performance HPN controller, coupled with an HPN transceiver system incorporating advanced digital signal processing (DSP)-based channel units and Global Positioning System (GPS)-based timing and synchronization units. The subsystem software, operating within the COMSAT Multiprocessor Operating System (COSMOS), implements all of the required GSM/SS7 and ICO air interface protocols, as well as sophisticated algorithm procedures to deliver messages in a multisatellite, multi-SAN environment. The HPN subsystem is designed around a high-availability architecture and provides sophisticated operations, administration, and maintenance functionality.

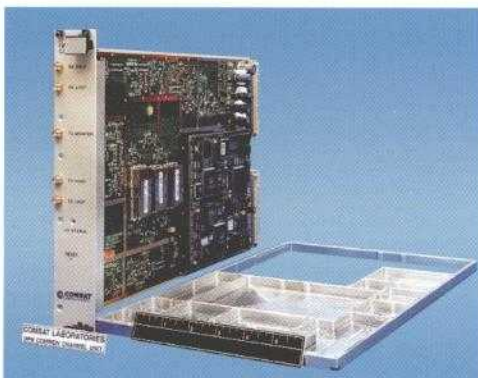
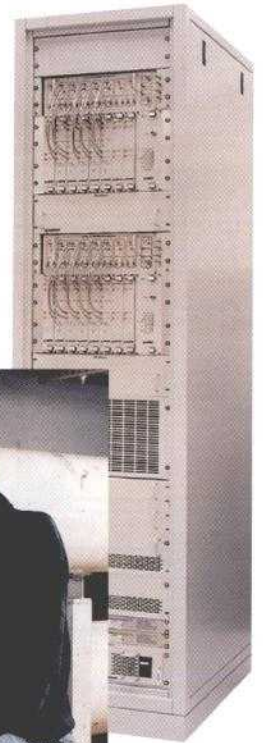

HPN Channel Unit

COMSAT Laboratories' HPN channel unit is a versatile signal processing platform that incorporates software-programmable transmit and receive channel units for use at ICO SAN sites. The channel unit motherboard incorporates an L-band signal interface, right- and left-hand polarization selection, transmit and receive up- and down-converters, synthesizers, A/D and D/A converters, and power supply conditioners. The channel unit digital daughtercard incorporates the channel unit controller, the DSP devices, and the digital modulation/up-/down-conversion circuits employing frequency-agile direct digital synthesizer (DDS) technology.

High-Speed Gateway

COMSAT Laboratories, under contract to COMSAT Mobile Communications (CMC), designed, developed, delivered, and installed high-data-rate gateway switches (HGSS) to interconnect CMC's Inmarsat Standard A and Standard B land earth stations (LESS) with the ISDN networks operated by US interexchange carriers. The switches enable CMC to offer global 56/64-kb/s high-speed data services (A-HSD and B-HSD) to mobile users via LESSs in Connecticut, California, and Malaysia.

ADVANCES IN HGS TECHNOLOGY AT COMSAT LABORATORIES

- Supports fixed-to-mobile, mobile-to-fixed, and both intraservice and interservice mobile-to-mobile calls from any ocean region to any other.
- Implements real-time call control—the Inmarsat-specific signaling to the LES access and control equipment (ACE) for A-HSD and B-HSD.
- Provides the ISDN protocols and protocol compensation functions necessary to ensure interworking with the ISDN.



COMSAT Laboratories' high-data-rate gateway switch is installed at the Southbury and Santa Paula land earth stations.

Onboard Processing Technology

COMSAT Laboratories is actively involved in systems studies, computer simulation, design, development, and fabrication of onboard processing/switching subsystems for next-generation satellite systems. Systems studies include onboard multicarrier demultiplexers and demodulators (MCDDs), multicarrier modulators (MCMs), onboard FEC coding, fast packet switch architectures, onboard congestion control, digital

beamforming networks, and onboard network control subsystems. Hardware development includes an engineering model onboard reference burst generator, a high-speed optic ring switch, a prototype fast packet switch, 120-Mb/s remodulators, a prototype MCDD, and a multicarrier demodulator chip.



A multicarrier demodulator ASIC device developed at COMSAT Laboratories is capable of simultaneously demodulating up to 24 channels, representing mixed QPSK carriers at transmission rates from 64 kb/s to 25 Mb/s and sampled at a fractional number of samples per symbol.

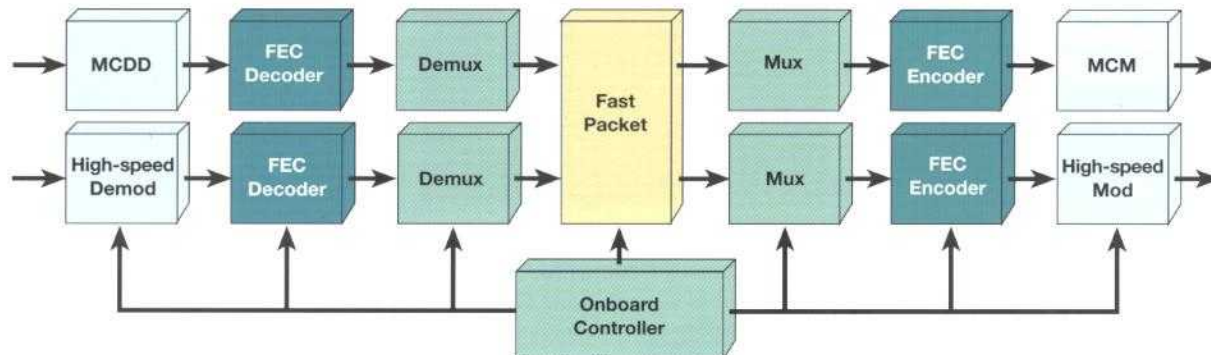

Low-Cost TDMA Traffic Terminal

COMSAT Laboratories' Low-Cost TDMA Traffic Terminal (LCT), manufactured by L-3 Communications Global Network Solutions (formerly Aydin Communications), is a second-generation 120-Mb/s terminal that is fully compliant with INTELSAT IESS-317 and EUTELSAT EESS-201 specifications. The design incorporates the latest microprocessor, DSP, programmable logic, and display technologies to realize a terminal that can accommodate up to 60 E1 direct digital terrestrial interfaces in a single rack. The fully integrated graphical user interface was developed based on years of interaction with AT&T and other earth station operators. It provides a powerful and easily understood means for controlling the terminal from either a local or remote user console.



The LCT incorporates an advanced digital modem design with a soft-decision FEC module to provide virtually error-free performance at normal system operating points, and permits the use of smaller earth station antennas. Its advanced monitoring and maintenance features exceed required specifications and contribute significantly to the terminal's ease of operation and maintenance. COMSAT Laboratories' LCT has been tested and approved for European Compliance (CE).



Modem Technology

The modem R&D and product development capabilities at COMSAT Laboratories span applications from 600 b/s to 300 Mb/s and include numerous modulation types, as well as continuous and burst-mode (TDMA) operation. The modems include custom analog front ends, software programmable logic, and ASIC digital implementations. A few examples are illustrated here.

BELOW: This flexible multicarrier digital tuner employs fast Fourier transform (FFT) processing to extract, filter, and down-convert as many as 24 carriers from a 9-MHz spectrum segment.

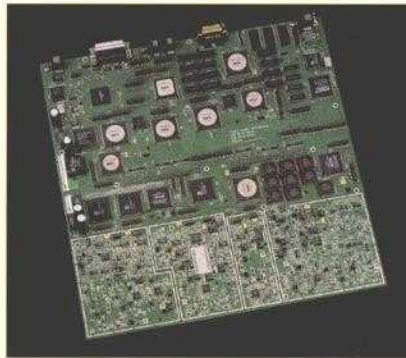
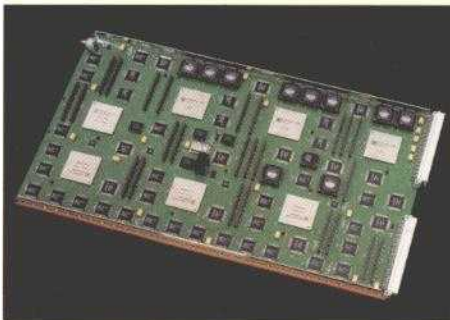

ABOVE: The single-board LINKWAY™ TDMA terminal incorporates a 2.5-Msymbol/s burst-mode QPSK modem featuring operation at low S/N and fast-settling synthesizers for rapid burst-to-burst frequency changes.



The 120-Mb/s burst mode QPSK modem is a major component of the Low-Cost TDMA Traffic Terminal.

Voiceband Processing

Voiceband processing research at COMSAT Laboratories includes work in voiceband signal processing, compression, channel coding, and transmission efficiency. Products are developed that enable the robust, bandwidth-efficient transmission of voice and voiceband signals over mobile and satellite systems.

Low Bit-Rate Speech Coders

An adaptive multirate (3.6/2.4/1.2-kb/s) nested voice codec patented by COMSAT Laboratories provides outstanding robustness against varying channel conditions in wireless communications systems. The coverage area of a wireless system can be extended with the additional (3-dB) link margin provided by the nested voice codec, with no increase in power or bandwidth requirements.

Turbo Codes

Turbo codes—also known as parallel concatenated codes—achieve unprecedented performance by processing the sequence of received symbols in several iterations. These additional iterations, along with increased interleaver size, result in an increase in the processing delay.

High-bit-rate data can tolerate an interleaving depth of several thousand bits while introducing minimal additional delay. The delay constraint for low-bit-rate voice, multimedia services, or short packet data transmission mandates a short interleaving depth. Among several types of interleaving proposed for short messages, a zigzag reverse block interleaver developed at COMSAT Laboratories yields excellent bit error ratio (BER) when used in conjunction with a four-state turbo code of rate 1/3.

CDMA Briefcase Terminal

COMSAT Laboratories' briefcase Ku-band spread spectrum terminal prototype uses code-division multiple access (CDMA) with a star network topology for personal portable or maritime mobile telephony. Spread spectrum technology permits a significant reduction in the size of the antenna (a 0.3-m flat plate) and terminal compared to conventional VSAT Ku-band terminals (with their 1.8-m dishes). The briefcase terminal is particularly well suited to complementing and extending national telephone networks in emerging telecommunications markets via international, regional, or domestic C- or Ku-band satellites.

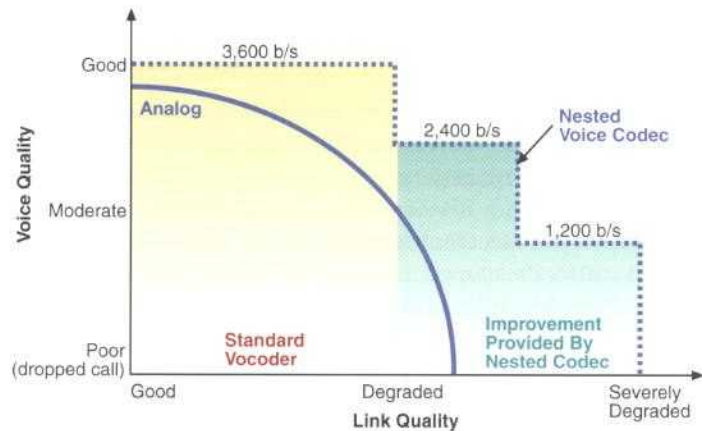

COMSAT Laboratories' patented nested voice codec improves speech quality in a faded environment.

- 4-state Turbo Code Rate 1/3
Interleaver Size: 192 b
Decoding Iterations: 8
- 64-state Convolutional Code Rate 1/3

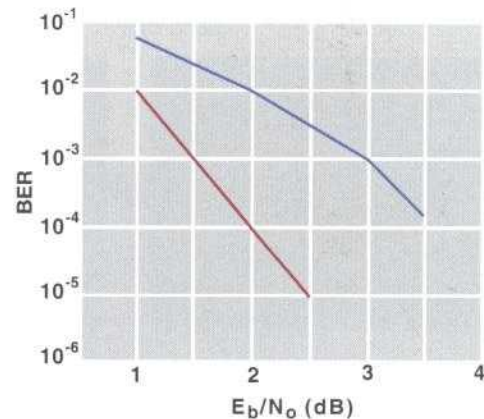

The Laboratories' turbo code algorithm outperforms conventional codes.

A prototype CDMA terminal developed at the Laboratories provides 4.8-kb/s voice and 2.4-kb/s fax/data using low-cost Ku-band space segment.



Flat Plate Antenna

Innovative flat plate antenna products—for which COMSAT Laboratories holds several patents—have been successfully introduced for Japanese and European direct-to-home (DTH) markets through a license arrangement with a major Japanese consumer electronics manufacturer. An improved product was also developed to provide DTH TV services in the Middle East for NILESAT.



COMSAT Laboratories' flat plate antenna is licensed to Satellite Equipment Manufacturing Corp. (SEMC), Egypt, for use with NILESAT DTH service.

INSAT Mobile Satellite System Ground Network

S-Band Terminals. COMSAT Laboratories' S-Band Portable Terminals were developed to operate with India's INSAT 2 and INSAT 3 satellite mobile communications payload packages. The terminals feature a detachable antenna electronics unit with a unique flat plate antenna design and RF electronics. The modem unit in the lower half of the terminal provides 6.4-kb/s voice, and 2.4-kb/s fax and data services.

The S-Band Maritime Terminal consists of above-deck equipment with an antenna electronics unit mounted on a three-axis-stabilized tracking pedestal. Antenna control commands are issued by a control unit inside the below-deck equipment, which provides user interfaces for voice, fax, and data, as well as a GPS interface.

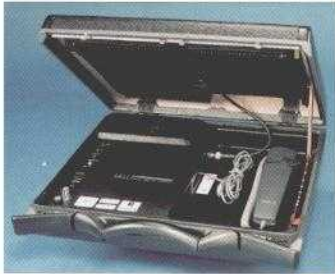

INSAT S-band briefcase land mobile terminal.



INSAT S-band maritime terminal and control unit.

Hub Station Equipment. COMSAT Laboratories developed, installed, and field-tested the INSAT Mobile Satellite System (MSS) Hub Station at Bangalore, India. The station consists of the RF equipment, a ground network control center, and interfaces to the public switched network to provide on-demand communications channel assignment. The fully redundant RF equipment operates at C- and S-band frequencies and includes a reference frequency source, uplink and downlink frequency converters, a sophisticated automatic frequency control (AFC) system, and a monitoring and control facility.

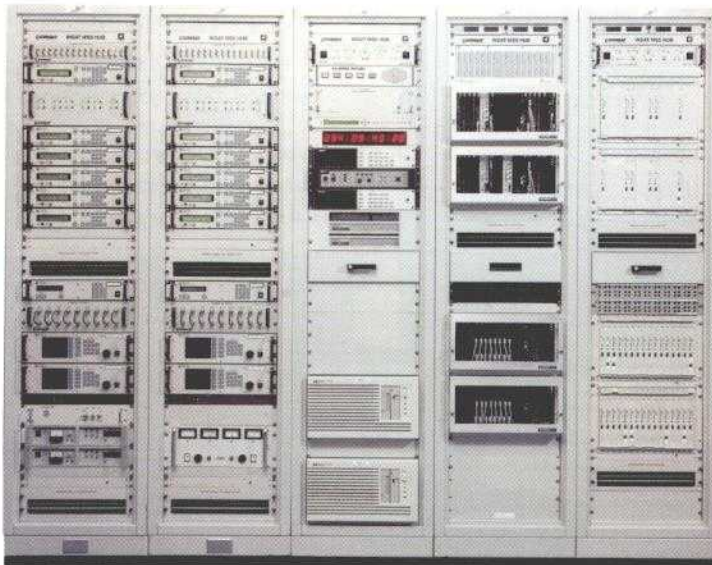

INSAT RF and hub equipment installed at Bangalore, India.

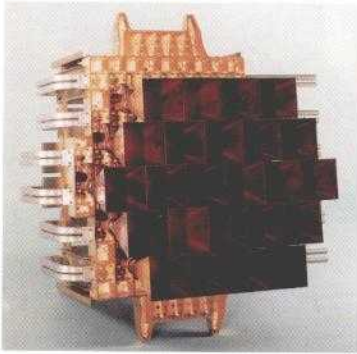

Ku-band high-power multibeam phased-array antenna.

Phased-Array Antennas

COMSAT Laboratories pioneered the development and demonstration of C-, X-, and Ku-band active phased arrays for reconfigurable multiple-beam satellites. Modular beamforming matrixes (BFMs) were developed at C-, X-, and Ku-bands using MMIC phase shifters, attenuators, and power amplifiers. Extensive tests were conducted to verify and validate the modeled array antenna performance, including antenna beam shape, steerability, and intermodulation.

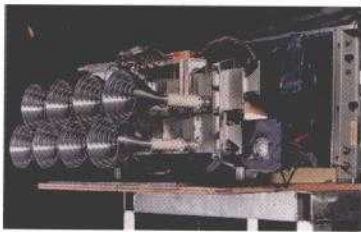

X-band antenna array with two steerable beams.

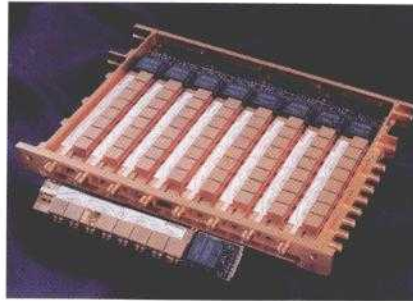

Ku-band modular beamforming matrix.

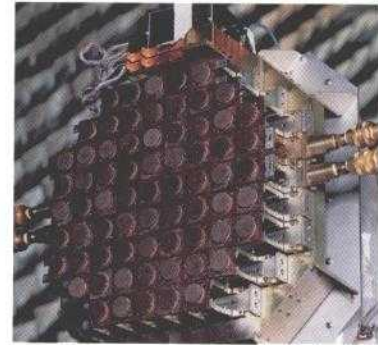

C-band multibeam phased-array antennas.

Advanced RF Subsystems

Many advanced RF subsystems have been manufactured at COMSAT Laboratories for commercial communications satellites. These include an in-orbit test transponder (IOTT) and Ka-band filters for ITALSAT, as well as MMIC-based C- and Ku-band channel amplifiers for NSTAR and the INTELSAT VII, VIIA, and VIII satellites. A dual-channel telemetry transmit power amplifier was also manufactured for the INDOSTAR-1 satellite for direct-to-home (DTH) satellite television broadcast services to Indonesia. Significant reduction in weight and power consumption was achieved with a novel C-band satellite receiver, a broadband microwave switch matrix, and BFMs for beam routing, shaping, and steering. These advanced RF subsystems are available for both satellite and ground applications.



Dual-mode cavity and printed filters.

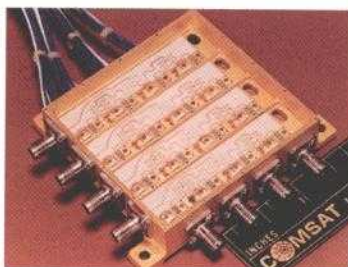

4 x 4 microwave switch matrix.



Miniaturized C-band satellite receiver.

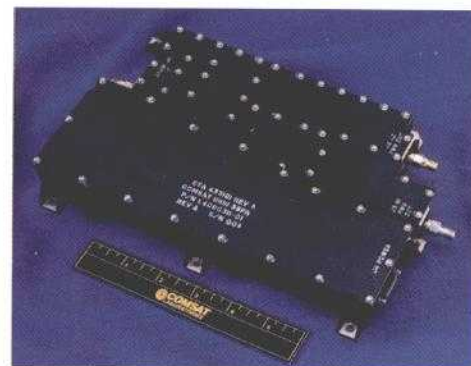

Indostar C-band telemetry transmitter.

PROPAGATION STUDIES & HARDWARE

COMSAT Laboratories has been a key contributor to several propagation studies sponsored by INTELSAT, NASA, and others. Ku- and Ka-band beacon measurement systems developed by COMSAT Laboratories have been used in several areas of the world, including Africa, Australia, South America, and India. Measurements taken by these systems led to the development of COMSAT Laboratories' comprehensive propagation model [the Dissanayake, Allnut, Haidara (DAH) model] that can be used to predict several propagation impairments. Because of its accuracy, this model has been adopted by both NASA and the International Telecommunication Union-Radio Sector (ITU-R) as the recommended procedure for calculating rain attenuation.

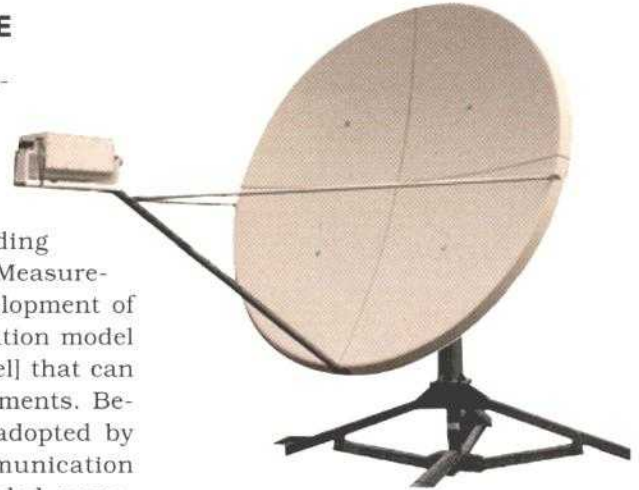

COMSAT Laboratories' Ka-band equipment was installed in Mexico to measure propagation effects in tropical regions.

BATTERY DEVELOPMENT

COMSAT Laboratories invented the widely used individual pressure vessel (IPV) Ni-H₂ aerospace battery and introduced it for commercial use in 1983. The Laboratories participated in the evolution of this technology through life testing and analysis spanning more than two decades of continual involvement with INTELSAT satellite programs. COMSAT Laboratories licensed the common pressure vessel (CPV) high-voltage Ni-H₂ battery technology to Eagle Picher, LLC. Iridium is using these batteries to meet the demanding charge/discharge cycle requirements of its low earth orbit satellites.

Today, battery research at COMSAT Laboratories is focused on lithium-ion batteries. Work is under way on high-capacity carbon anodes, mixed-oxide cathodes, and cell designs. Additional efforts focus on elucidating thermal and cycling behavior and resolving anomalies for NASA programs. COMSAT Laboratories is a team member with Eagle Picher in a DOD/NASA-sponsored program to develop aerospace lithium-ion batteries.

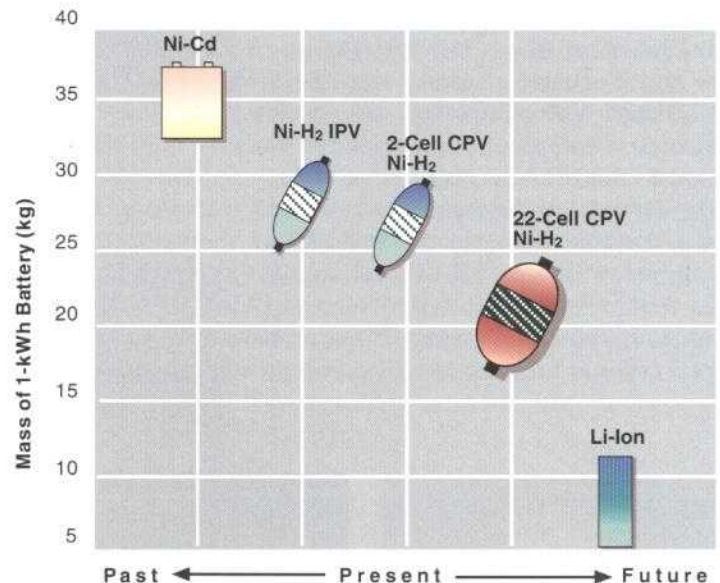

Systems



The systems engineers and developers at COMSAT Laboratories are experienced in all aspects of satellite system design and implementation. The Laboratories offers satellite service providers both off-the-shelf products and custom-developed solutions to support the planning and operation of advanced Ka-band and GEO/LEO/MEO satellites. Distributed computer-based systems that support advanced satellite communications networks in the areas of network control and management are designed, developed, and tested.

SYSTEM DEVELOPMENT

COMSAT Laboratories has extensive experience in developing a wide range of satellite system management, control, and planning facilities for both commercial and military customers. State-of-the-art computing technology includes relational databases, graphical user interfaces, client/server architectures, Web-based access, and a proven development process that covers all phases of the life cycle. The Laboratories provides systems and tools that include:

- Operational planning tools
- Network management and control systems
 - Advanced Communications Technology Satellite (NASA)
 - Interim System Planning Computer
 - Bandwidth Management Centers
- In-orbit testing and spectrum monitoring systems
- New TDMA Infrastructure (INTELSAT)
- Aeronautical Network Channel Management System (Inmarsat).



A mature software engineering process ensures low risk and high-quality development programs.

OPERATIONAL PLANNING TOOLS

COMSAT Laboratories has developed numerous software products to support the planning, analysis, and optimization of satellite communications systems. This software includes facilities that were developed or customized for specific customers, as well as generic tools offered as off-the-shelf products.

Transmission analysis and planning tools have been developed for both frequency- and time-division multiple access (FDMA and TDMA) systems. For example, the Laboratories developed all versions of INTELSAT's transmission planning facility—STRIP (Satellite Transmission Impairments Program)—to perform transmission plan analysis and optimization in support of INTELSAT's worldwide network operations.

General-purpose analysis and planning tools offered as off-the-shelf products include Satellite Tools and Resources (STAR), the Communications Planning System (COMPLAN), the Link Budget Calculator (LINK), the Antenna Coverage Program (ACP), the COMSAT Intermodulation Analyzer (CIA), and the Propagation Analysis (PA) program. A new Burst Time Plan (BTP) Generation System also was developed to support the modernization and expansion of INTELSAT's 120-Mb/s TDMA networks.

Additional design and testing tools offered by COMSAT Laboratories include the General Antenna Program (GAP), the Phased Array Program (ARRAY), the Beam Intermodulation Analyzer (BIA), and the COMSAT Antenna Verification Program (CAVP).

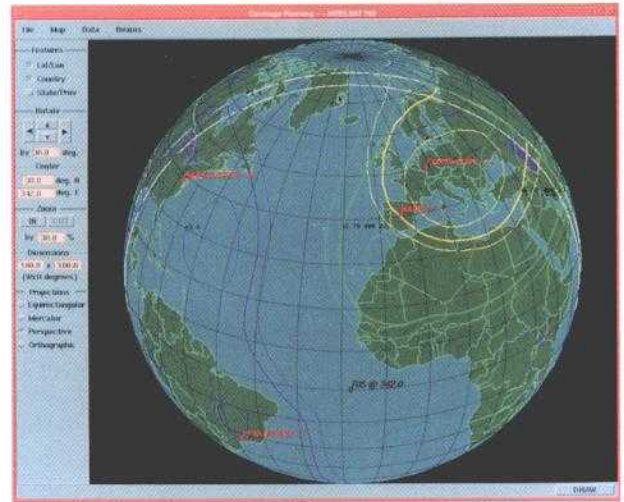

STAR Screen.

COMSAT LABORATORIES' SYSTEM PLANNING TOOLS

STAR: Provides a comprehensive database of satellite system parameters, as well as a set of analysis tools to determine system capacity and performance.

COMPLAN: Analyzes and optimizes transmission plans on multiple frequency reuse satellites.

LINK: Analyzes a communications link between two earth stations.

ACP: Computes antenna beam patterns, performs analyses, and displays the results on a world map.

CIA: Determines intermodulation products in satellite transponders or earth station high-power amplifiers.

PA: Provides three major propagation models for C-, Ku-, and Ka-band propagation analyses, including COMSAT's world-recognized DAH model (see p. 14).

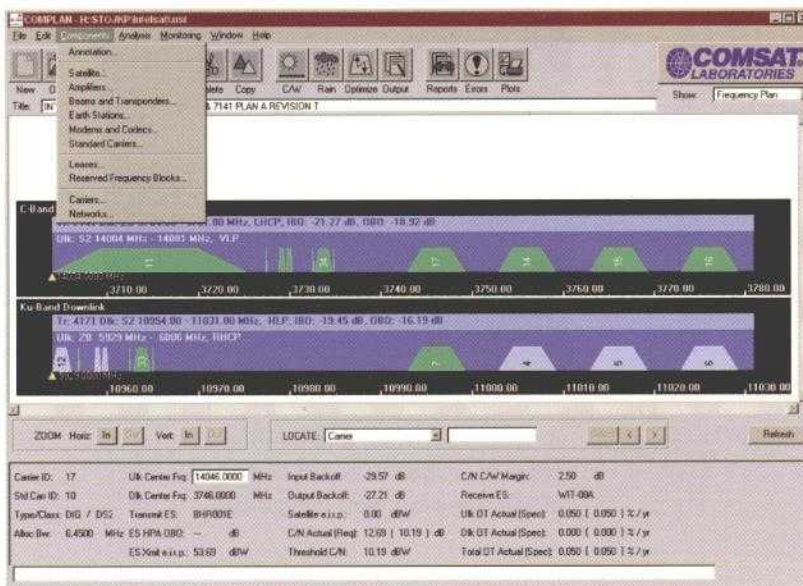

COMPLAN Screen.

NETWORK MANAGEMENT & CONTROL

Distributed computer-based systems developed at COMSAT Laboratories support the management and control of satellite communications networks. These systems have been implemented for a number of commercial, government, and military customers and have been extensively proven in day-to-day operational use under both normal and stressed conditions. Capabilities provided by these systems include operational planning and configuration management, dynamic capacity allocation, remote terminal management, link performance monitoring, transponder monitoring, and alarm

handling. Wherever possible, the system designs are based on industry standards such as Telecommunications Management Network (TMN) or Simple Network Management Protocol (SNMP) and employ off-the-shelf network management environments.



COMSAT Laboratories has extensive software development expertise employing current technologies such as object-oriented design, graphical user interfaces, relational databases, and Web-based development using C, C++, Ada, Java, and other languages.



ACTS Ka-band Master Control Station

COMSAT Laboratories designed, developed, manufactured, integrated, and tested the Master Control Station (MCS) for NASA's Ka-band Advanced Communications Technology Satellite (ACTS). The ACTS spacecraft is called the "switchboard in the sky" because it contains an intelligent onboard switch that incorporates demand-assigned multiple access and hopping spot beams. The MCS ground equipment actively reconfigures the satellite onboard processor as required by traffic demand, on a call-by-call basis. The station provides network configuration and initialization; call setup and tear-down; spacecraft telemetry, tracking, and control (TT&C); and database management functions. COMSAT Laboratories has operated the MCS at the NASA Glenn Research Center in Cleveland, Ohio, since 1993.

The Laboratories also developed the TDMA earth terminal and RF terminal for the NASA MCS. The RF Terminal Supervisor (RFTS) provides status and monitoring of earth station RF equipment via a color graphics display. It also coordinates other RF terminal activities, including adaptive rain fade measurement, antenna control, and the measurement subsystem. The measurement subsystem uses COMSAT's proprietary, preamble-based measurement techniques to measure power and carrier frequency in the downlink burst signals.

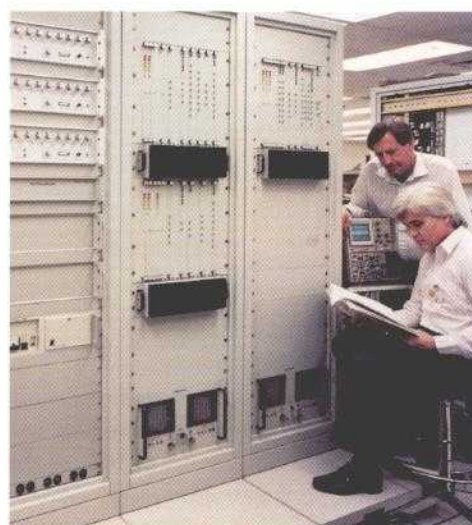

ABOVE: ACTS Ka-band Master Control Station.

ACTS TDMA terminal.

Interim System Planning Computer

COMSAT Laboratories' Interim System Planning Computer (ISPC) supports the Universal Modem System (UMS) in providing fixed-ground, transportable-ground, airborne, and ship users with survivable anti-jam, anti-scintillation, low-probability-of-exploitation, interoperable digital data communications. The UMS employs nonprocessing transponders on both US and Allied SHF satellite systems, including the Defense Satellite Communication System (DSCS). The ISPC is used to perform numerous network planning and management functions, including scenario definition, resource allocation, network implementation plan generation and distribution, network reconfiguration, link performance monitoring, alarm handling, orderwire messaging, database dissemination, cryptographic key management, satellite ephemeris propagation, and control handover.



ABOVE: Experienced instructors provide training in the use of COMSAT Laboratories' custom network management facilities and commercial software products.

RIGHT: Completely integrated functionality enables a BMC operator to access all system management functions from a single computer.



Bandwidth Management Center

In support of the Defense Information System Agency (DISA) Commercial Satellite Communications Initiative (CSCI) program, COMSAT Laboratories has developed and assists in the operation of Bandwidth Management Centers (BMCs) that support the operation of military communications networks over commercial satellites. The BMCs include software tools for performing link analysis, analyzing coverage, generating antenna coverage maps, performing detailed transmission planning, monitoring carrier performance, monitoring and controlling remote earth terminals, and handling all system faults, alarms, and events. All of these functions are integrated through a relational satellite system database.

The first BMC was installed at Clarksburg, Maryland, in January 1995 and has been providing service to DISA since that time. The second BMC was installed at Landstuhl, Germany, in 1997.

NEW TDMA INFRASTRUCTURE FOR INTELSAT

INTELSAT's 120-Mb/s TDMA networks, in operation since 1984 in the Atlantic and Indian Ocean Regions, are used by major telecommunications carriers to transmit public telephone services worldwide. COMSAT Laboratories is currently developing a new TDMA infrastructure (NTI) system that will allow INTELSAT to manage these networks more easily and replace existing equipment that is nearing the end of its useful lifetime. With the new equipment and software provided by COMSAT, INTELSAT will be able to schedule time for occasional-use customers much faster, automate many aspects of network administration, and more than double the number of customer terminals that can access each network. These innovative capabilities will result in significant cost savings and increased revenue for INTELSAT.

Elements of the NTI system include:

TDMA Control and Management System (TCMS)

The TCMS interfaces with the INTELSAT resource planning and spacecraft operations infrastructure to serve as a global network control and management facility. Use of the TCMS enables INTELSAT to control its networks remotely—from its headquarters in Washington, DC—rather than from the four separate earth stations currently used.

Reference Terminal Equipment (RTE)

Each TDMA network has two RTEs: a primary and a backup. The RTEs distribute control information from the TCMS to the traffic terminals and provide a timing reference (such as a master clock) that permits each terminal to synchronize transmission.

TDMA System Monitor (TSM)

This equipment monitors all traffic terminals to assess the transmission quality from each earth station.

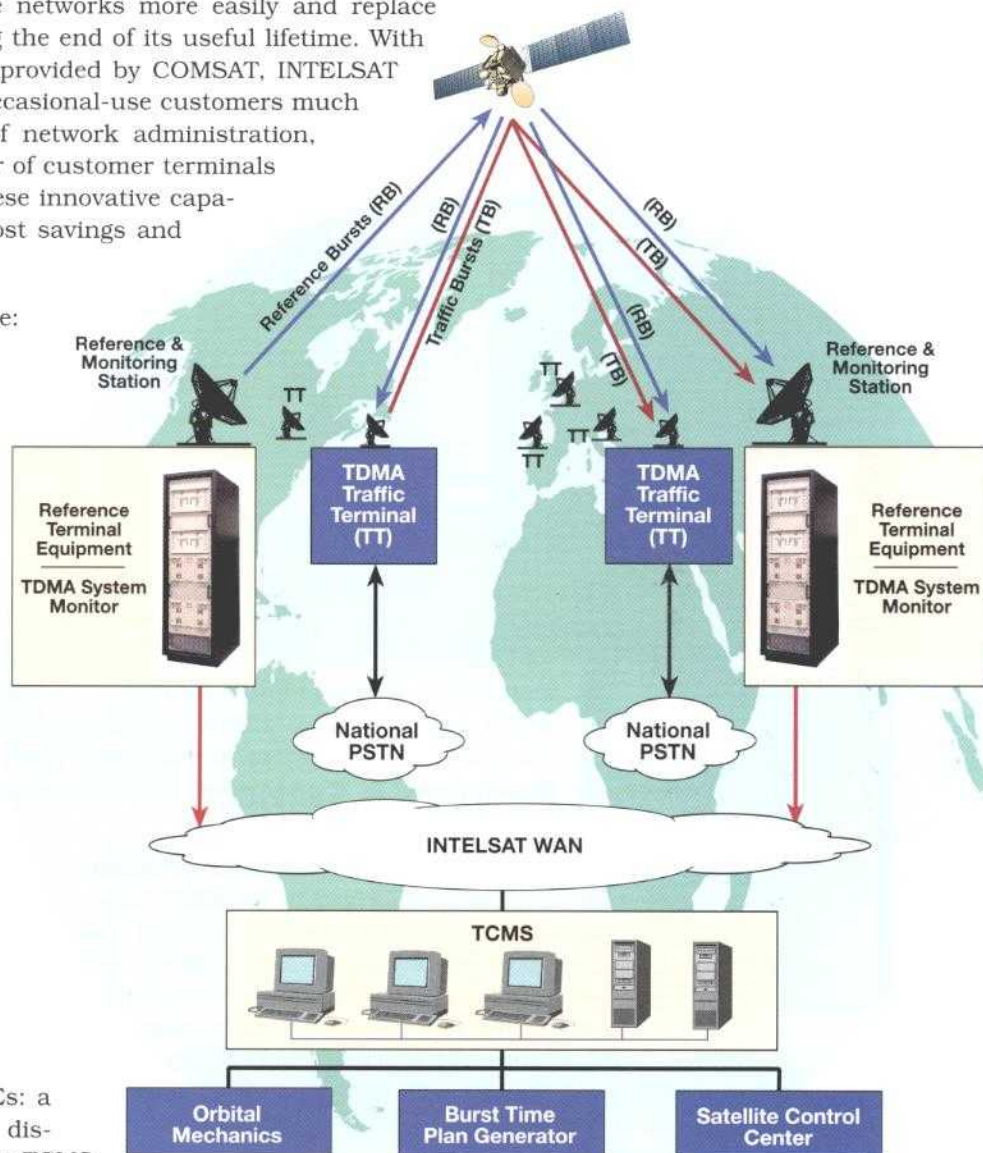

INMARSAT AERO NETWORK CHANNEL MANAGEMENT SYSTEM

COMSAT Laboratories designed and developed an aeronautical Network Channel Management System (NCMS) for Inmarsat. The new NCMS makes more efficient use of the available spectrum while maintaining or improving the quality of service and maximizing conformance to safety standards.

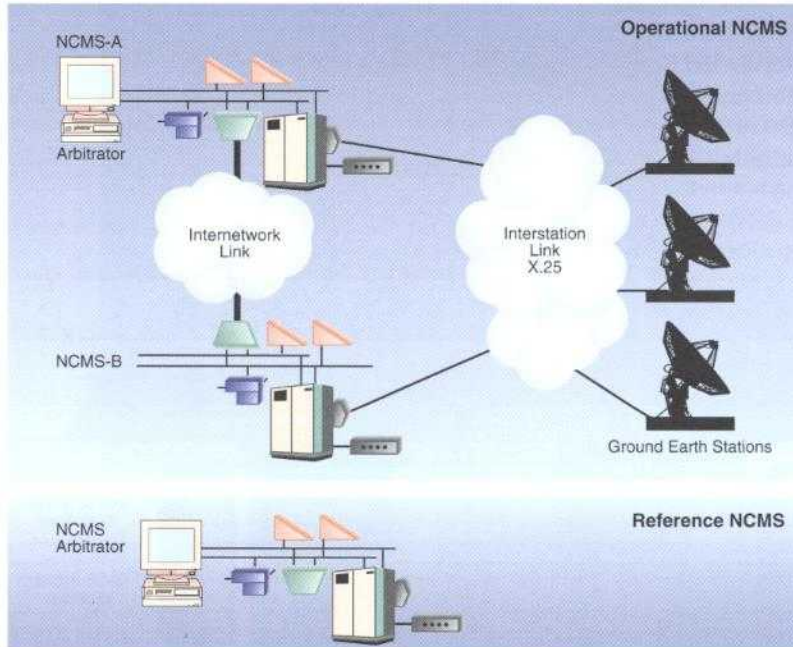

For network resources management, the Laboratories-designed optimization algorithms that are capable of adaptive operation in a priori block assignment and/or on-demand assignment modes, based on traffic load conditions. The NCMS is also responsible for maintaining Regional Location Register aeronautical earth station log-on databases with interconnection capability to the Inmarsat Mobility Management System.

COMSAT Laboratories developed Inmarsat's fully integrated NCMS.

IN-ORBIT TEST FACILITIES & SERVICES

In-orbit testing (IOT) and in-service monitoring of communications spacecraft have been performed by COMSAT Laboratories for more than 20 years, and the Laboratories has continually improved both the techniques and facilities used in these applications. To ensure a successful IOT campaign, COMSAT's comprehensive IOT services include campaign planning, on-site installation and checkout, payload test support, data analysis, anomaly investigation, engineering support, and customer training.

COMSAT Laboratories' Portable IOT System is an integrated suite of in-orbit test measurement hardware and software that enables satellite operators to perform quick, accurate, and detailed testing of communications satellites following launch into orbit. Designed for transportability, rapid deployment, and rugged reusability, the COMSAT Portable IOT System can be connected to one or more earth station antennas operating in the UHF, L, S, C, X, Ku, DBS, and Ka frequency bands.

The Laboratories has provided automated IOT systems to customers such as INTELSAT, SBS, GTE, Hughes, Space Systems/Loral, and Loral Orion.

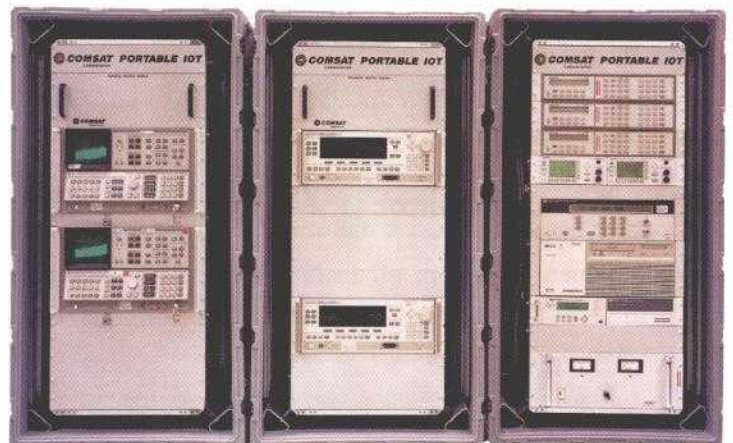

Test & Evaluation Services

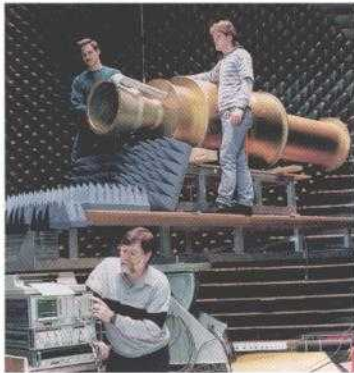

COMSAT Laboratories provides world-class test and evaluation services to a variety of international and domestic customers. Services include satellite procurement and construction support, spacecraft battery evaluation, voice processing subjective evaluation, earth station calibration and evaluation, and system simulation and evaluation.



SATELLITE PROCUREMENT & CONSTRUCTION SUPPORT

On-time, reliable delivery of a satellite is critical to the success of any satellite program. To help ensure this success, the experience and extensive capabilities of COMSAT Laboratories are available to assist satellite owners and operators worldwide. With more than 30 years of experience in satellite communications, the Laboratories can provide management and engineering support for all phases of satellite programs, including

- technical audits
- proposal evaluation
- conceptual design studies
- contract negotiation support
- satellite construction monitoring
- satellite launch operations support
- development of RFPs and technical specifications for space segment, launch, TT&C, and in-orbit test (IOT) services.

These services are provided by COMSAT staff at our facilities in El Segundo and Sunnyvale, California, augmented by technology specialists from COMSAT Laboratories in Clarksburg, Maryland.



COMSAT Laboratories maintains offices at spacecraft manufacturer facilities to monitor satellite construction.

SPACECRAFT BATTERY EVALUATION

COMSAT Laboratories maintains a superior battery testing and evaluation laboratory to monitor battery performance, assist with in-orbit battery operations, perform anomaly investigations, and develop advanced energy storage devices. Customer-supplied batteries are tested using state-of-the-art equipment, including HP computer-controlled data acquisition systems, programmable power supplies and electronic loads, and customized controllers. An assortment of temperature chambers, recirculating fluid temperature baths, and cold plates are used to maintain environmental temperatures. An uninterruptible power supply is available, and sensor-activated alarms are strategically positioned to protect test devices and personnel.

The Battery Analysis Laboratory at COMSAT Laboratories is used to perform destructive physical analysis on cells that have been removed from life testing. The analysis evaluates cell integrity and determines cell wearout and failure mechanisms. Precycled cells are also analyzed to assess flight qualification and adherence to specification. The analysis laboratory employs COMSAT-derived, NASA-approved chemical techniques and is equipped to evaluate electrochemical performance at the cell and plate levels. The facility houses modern analytical instrumentation to perform comprehensive and precise measurements.

VOICE PROCESSING SUBJECTIVE EVALUATION

COMSAT Laboratories operates a world-class Subjective Speech Evaluation Laboratory serving a variety of customers who require independent assessment of voice codecs and communications systems quality of service. It is currently

one of the largest commercial expert laboratories in this field in the world. Over the last 4 years, the evaluation facility has performed more than 200 voice codec quality assessments for a variety of vocoder/telecommunications network developers. These tests primarily involved codecs with channel bit rates of 8 kb/s or less and were conducted in multiple languages

Inmarsat Mini-M speech codec selection and testing were performed primarily at COMSAT Laboratories, as were the TIA HR-TDMA and CDMA cellular speech codec selection efforts, and the speech quality testing for the new US DOD VPC 2.4-kb/s codec. The Laboratories also regularly conducts vocoder evaluations to ITU-T and EIA/TIA test plans.

COMSAT Laboratories has been actively involved in correlating the "quality" scores resulting from the use of objective measurement tools (OMTs) to subjective scores from listening tests performed on the same recorded samples, and is aggressively promoting this methodology.

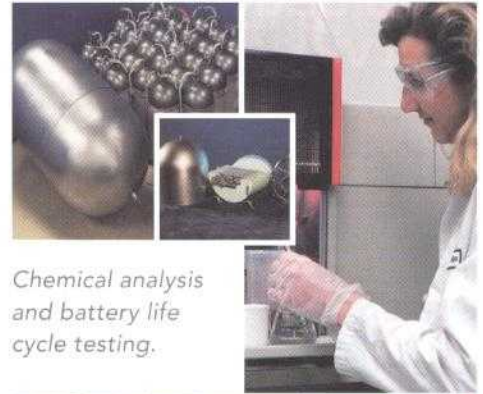

Chemical analysis and battery life cycle testing.



PARTICIPATION IN GLOBAL VOCODER STANDARDS ACTIVITIES

Multinational Codec Selection Efforts G.726, G.728, G.729 (including Annex A), and subsequent 4-kb/s vocoder work.

Speech Quality Experts' Group (SQEG) of ITU-T Study Group 12, as well as more general activity in SGs 12 and 16.

TIA Minimum Performance Standards Tests for CDMA, TDMA, and APCO-25 vocoder developers.

Serviceability and Reliability of TIA Tests TR45.3.5 and TR45.5.1.1.



EARTH STATION CALIBRATION & EVALUATION

Reflector antenna and feed development support at COMSAT Laboratories centers on technical consulting, antenna evaluation and verification, feed and probe design, and on-site measurement software such as the COMSAT Antenna Verification Program (CAVP). Antenna and feed evaluation and verification entail the full measurement and characterization of antennas and antenna feed systems for performance verification. Recently, COMSAT Laboratories' Antenna Systems Department undertook significant antenna pattern verification work for Raytheon, to aid in developing a triband antenna terminal for the US military.



Earth station technical consulting includes a variety of support for customers who require assistance with antenna systems.

Feed and probe design involves the design, manufacture, and evaluation of antenna feeds for COMSAT and other companies. COMSAT Laboratories has been actively designing feeds for many years and recently completed the design, construction, and measurement of C- and Ku-band scalar feed horns.

SYSTEM SIMULATION & EVALUATION

COMSAT Laboratories has more than 20 years' experience in hardware simulation and the evaluation of satellite communications systems. Specially designed simulators—employing actual satellite hardware components—can emulate virtually any satellite communications payload configuration in a controlled laboratory environment. Such setups are used to experimentally assess system performance and identify limits to system operation.

Available services include:

- communications system evaluation
- channel simulation for fixed or mobile systems
- transmission parameter optimization
- satellite transmission system design and analysis
- transponder/channel simulator construction
- specialized system fabrication
- system integration and testing
- calibration of software models.



C-BAND SIMULATOR

- 6 GHz transmit, 4 GHz receive
- Single receiver
- 3 6-W TWTAs
- 1 30-W SSPA
- Configured as:
 - 3 contiguous INTELSAT 36-MHz transponders
 - or
 - 2 contiguous INTELSAT 72-MHz transponders and 1 41-MHz INTELSAT video transponder.

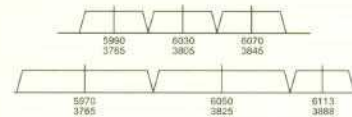

KU-BAND SIMULATOR

- 14 GHz transmit, 12 GHz receive
- Dual receiver
- 6 transponders, each with a 20-W TWTA
 - 3 at 72 MHz (INTELSAT spec.)
 - 3 at 54 MHz (domestic spec.)
- Capable of simulating adjacent transponder and cross polarization interference simultaneously.

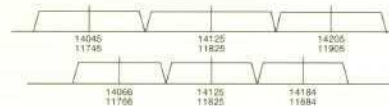

COMSAT Laboratories

22300 COMSAT Drive

Clarksburg, MD 20871-9471 USA

Telephone: +1 301 428 4000

Fax: +1 301 428 4700

e-mail: labsinfo@comsat.com

Web Site: www.comsat.com

Marketing & Product Management

Jack Hangen: +1 301 428 4030

Fax: +1 301 428 4700

e-mail: jack.hangen@comsat.com

Human Resources

Colleen A. Rust: +1 301 428 4381

Fax: +1 301 428 7716

e-mail: colleen.rust@comsat.com

Intellectual Property

Leslie A. L. Borden: +1 301 428 4784

Fax: +1 301 428 4260

e-mail: leslie.borden@comsat.com



Technology & Systems

Prakash Chitre: +1 301 428 4167

Fax: +1 301 428 7747

e-mail: prakash.chitre@comsat.com

Government Programs

William L. Cook: +1 301 428 4682

Fax: +1 301 428 3186

e-mail: cookw@sdd.comsat.com

Product Development

Richard R. Lindstrom: +1 301 428 4347

Fax: +1 301 601 5960

e-mail: rich.lindstrom@comsat.com

Program Development

David N. Meadows: +1 301 428 4681

Fax: +1 301 428 5414

e-mail: david.meadows@comsat.com

Satellite Systems & Consulting

Albert J. Smith: +1 301 428 5411

Fax: +1 301 428 5414

e-mail: albert.smith@comsat.com



COMSAT Laboratories

22300 COMSAT Drive

Clarksburg, Maryland 20871

USA

 +1 301 428 4000

 labsinfo@comsat.com

 www.comsat.com

 +1 301 428 4700

